



The Safety Beacon is for informational purposes. Unit safety officers are encouraged to use the articles in the Beacon as topics for their monthly safety briefings and discussions. Members may also go to LMS, read the Beacon, and take a quiz to receive credit for monthly safety education.

April 2020

## ***A few quick COVID-19 updates...***

Mark Dulaney, CSP  
CAP Assistant Chief of Safety

Have questions about how CAP is responding to COVID-19? **Read through this month's issue and find out where you can get updates, as well as finding some tips on how to protect yourself and others from this virus.**

If you have any questions on safety policy, the new safety regs, or anything else about the new safety program, drop us a line at [safety@capnhq.gov](mailto:safety@capnhq.gov) and we'll try to use the Beacon to help spread the word and clear up any questions that may be out there.

The NHQ Safety Staff is following CAP guidance and working from home during this crisis, but we will continue to engage with you in every possible way. Feel free to contact us via email and we will do everything we can to get back with you as soon as possible.

\*\*\*\*\*

### **Update on Annual Safety Risk Management Day**

Due to the ongoing issues and concerns with COVID-19 the requirement to complete the Annual Safety Risk Management Day by 31 March has been waived.

We continue to encourage you to find alternate methods of presenting the information such as virtual presentations.

\*\*\*\*\*

### **Share your experiences with the CAP/SE**

We would like to hear about your success stories. How have you been able to continue spreading the safety and risk management message in the COVID-19 environment? Are there things you tried that didn't work? Let us know about that as well.

Just email us at [safety@capnhq.gov](mailto:safety@capnhq.gov) and share them with us.

# COVID-19 – Checking on Our Members

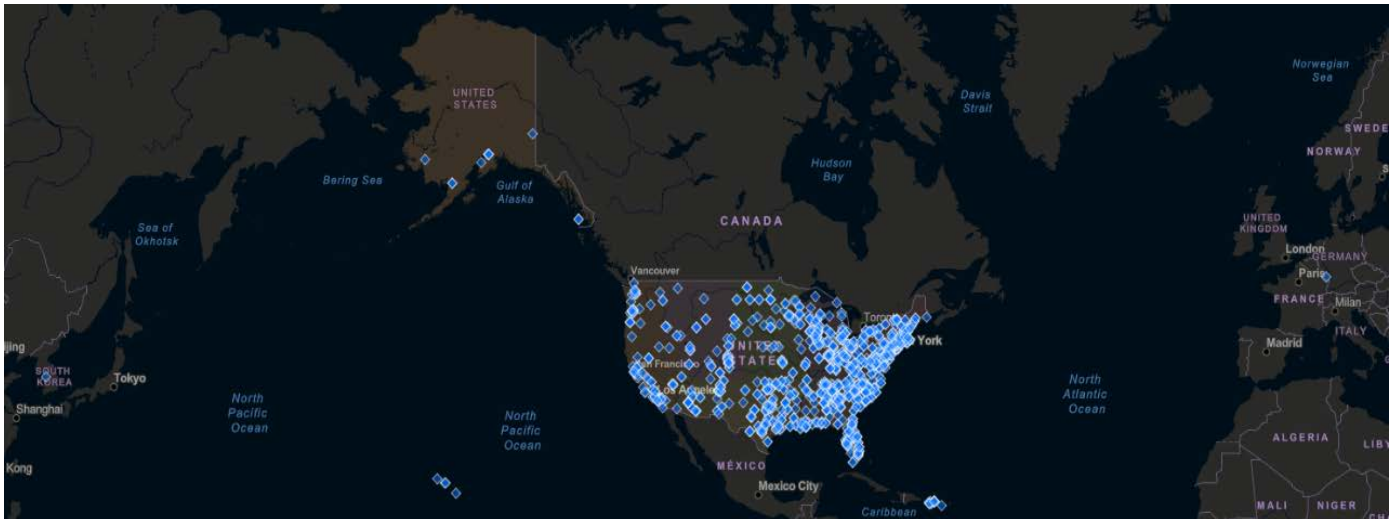

This global map represents CAP units around the world who have reported in on the status of their members, allowing the CAP National Command Team to monitor the welfare of members worldwide.

As of 6 April 2020, we are fortunate that less than 20 members have tested positive; indicative of strong awareness and excellent application of risk management in all of CAP's COVID-19 decisions from leadership down to the individual members. Risk management is a continuous process, and that means staying aware of the changing hazards and updating risk controls on a continuous basis

This type of information is a vital piece of data that helps CAP leaders make key decisions about our way forward. Maps like the one below, courtesy of the CDC, help CAP leaders monitor the situation. Based on a thorough understanding of the risks, the national/state/local guidelines, and the status of our own members, CAP leaders can make the best decisions to support our Nation and local communities while minimizing the risk to CAP members. In short, risk management is guiding CAP decisions during this COVID-19 crisis and it can help guide your decisions also.

This issue of the Beacon will help you find tools and information that can be shared with everyone to limit the spread of this virus and find new ways to accomplish our missions.

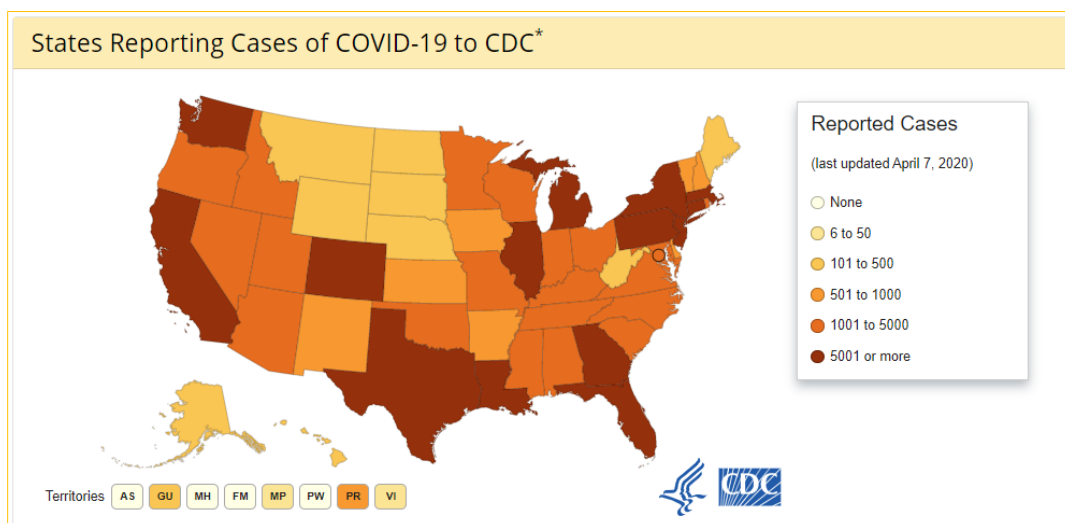

# Managing our response to COVID-19

## *Finding the Information YOU Need*

The full impact of the COVID-19 virus on each of us and our country may not have peaked yet. Every person has been impacted by this virus in some form.

In response to the concerns surrounding the spread of the COVID-19 virus the CAP team has established a web page to serve as a central repository for all information related to our operations and COVID-19. You can find updates from the Commander, Cadet Programs, Operations, Safety and more. We invite you to visit the site and make use of all the tools and information available.

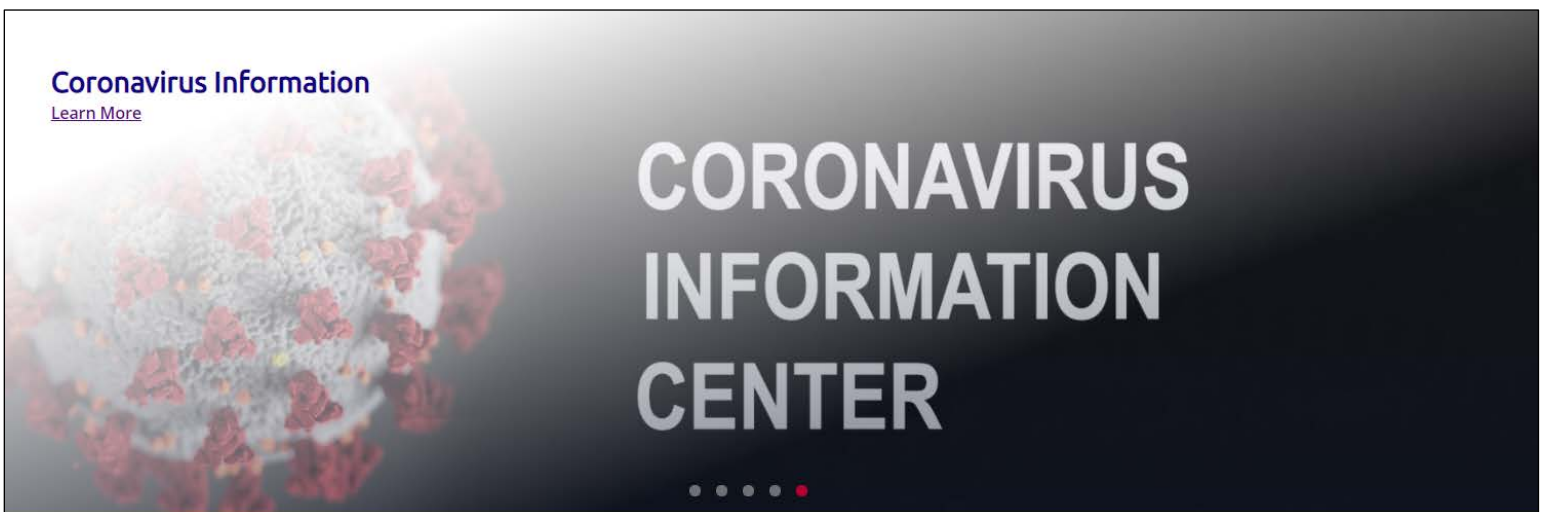

This remains a fluid situation and we encourage you to check back frequently ... the page will be updated as information changes. There's a link at the top of the homepage on [gocivilairpatrol.com](http://gocivilairpatrol.com) , that looks like this ...



Click here: [Civil Air Patrol COVID-19 Information Center](#)

# [Risk Management Key to COVID-19 Response](#)

**Visit the CAP Safety pages and check out our tools, tips and exercises to help you apply risk management principles to dealing with the COVID-19 virus!**

There is some NEW training that will help you with your COVID-19 decisions, while also reinforcing the importance of risk management and teaching members how to use the CAPF 160 and other CAP risk management tools! There are PowerPoint presentations as well as an instructor guide to help members see how RM can guide new COVID-19 risk decisions in tasks as common as shopping for groceries or flying an airplane.

Check out our stoplight chart to help you decide the level of risk an activity might present. Or find out how to apply the 5M model to the current situation and your planned event.

**These presentations are perfect for safety discussions during your virtual unit meetings. Increase awareness while you see how easy it is to use the CAPF 160.**

[Check it out here](#)

## **RISK MANAGEMENT AND COVID-19**

Coronavirus and COVID-19 present a completely new landscape of hazards and risk to our members and our communities. Risk Management provides a process for identifying, assessing, and responding to these risks. This page will provide tools and resources to help with those COVID-19 risk decisions.

### Objectives:

- Provide tools and training to help members use risk management decisions to reduce their exposure to the coronavirus and minimize the effects of COVID-19
- Reinforce the CAP Safety Vision that risk management "is on-going process used in the planning and execution of all CAP missions and activities, in groups and as individuals."

### Training:

**USE THESE EXERCISES FOR YOUR NEXT SAFETY MEETING!! These resources are applicable to all members. Commanders and Safety Officers in all units should work through these training exercise with their members to help them with their COVID-19 decisions and reinforce the use of risk management in their daily lives.**

# Facebook!



**That's right!**

## **CAP Safety has a new page on Facebook!**

Click on this [CAP Safety Facebook](#) link, or log into Facebook and search for "CAP Safety."

This is a closed "Group" page, open to active members of CAP or others invited by the CAP Safety team. We'd primarily like it to be a place where safety officers can discuss CAP Safety, risk management in CAP activities and missions, and the innovative ways you are teaching and helping members how to use risk management in everything they do. All you need to do is ask to join and answer a couple very simple questions.

That is especially important now ... share the ways you are reaching out, staying in touch, and helping spread the word about risk management while we all face the COVID-19 crisis together.

We welcome participation and encourage you to interact with us often and to comment about the content you find. We do not discriminate against any views, but administrators and moderators reserve the right to delete content or to block users who violate Facebook's official terms of use or create multiple off-topic posts. In short: Be respectful. Be smart. Be professional. Add to the discussion and help grow our community in constructive ways.

**Let's Talk Safety!**

# Homemade Masks or “N95?”



With widespread guidance to wear face coverings in public to help prevent the spread of the COVID-19 virus, we hear a lot about the N95 respirator. Ever wonder what it is? Do you need one? The **N95 respirator** is a protective mask designed to achieve a very close facial fit and very efficient filtration, blocking 95% of airborne particles. Those masks are in very high demand by the medical professionals who need them to perform their important work ... *we don't need them for day-to-day activity!*

**So, what kind of face coverings are we supposed to use?**

**How do we follow their guidance and avoid exposure to the virus?**

**It is critical to emphasize that maintaining 6-foot social distancing remains important in slowing the spread of the virus. Wearing a face covering does NOT change the requirement to maintain 6' separation!**

The CDC advises that the use of **simple cloth face coverings** will help slow the spread of the virus and help people who may have the virus, and do not know it, from transmitting it to others. Cloth face coverings can be fashioned from household items or made at home from common materials at low cost. Check on local, state and national recommendations for wearing the face covering ... they may be required in your area.

**So, how do I make one of these face coverings?**

For more information on how to make your own face covering check out [this instructional video](#) featuring the Surgeon General of the United States.



**For the CDC's step-by-step instructions on making your own masks, check out the next two pages!**

**(or download those pages by clicking [HERE](#))**

**Stay vigilant ... stay well**

# Use of Cloth Face Coverings to Help Slow the Spread of COVID-19

## How to Wear Cloth Face Coverings

Cloth face coverings should—

- fit snugly but comfortably against the side of the face
- be secured with ties or ear loops
- include multiple layers of fabric
- allow for breathing without restriction
- be able to be laundered and machine dried without damage or change to shape

## CDC on Homemade Cloth Face Coverings

CDC recommends wearing cloth face coverings in public settings where other social distancing measures are difficult to maintain (e.g., grocery stores and pharmacies), **especially** in areas of significant community-based transmission.

CDC also advises the use of simple cloth face coverings to slow the spread of the virus and help people who may have the virus and do not know it from transmitting it to others. Cloth face coverings fashioned from household items or made at home from common materials at low cost can be used as an additional, voluntary public health measure.

Cloth face coverings should not be placed on young children under age 2, anyone who has trouble breathing, or is unconscious, incapacitated or otherwise unable to remove the cloth face covering without assistance.

The cloth face coverings recommended are not surgical masks or N-95 respirators. Those are critical supplies that must continue to be reserved for healthcare workers and other medical first responders, as recommended by current CDC guidance.

## Should cloth face coverings be washed or otherwise cleaned regularly? How regularly?

Yes. They should be routinely washed depending on the frequency of use.

## How does one safely sterilize/clean a cloth face covering?

A washing machine should suffice in properly washing a cloth face covering.

## How does one safely remove a used cloth face covering?

Individuals should be careful not to touch their eyes, nose, and mouth when removing their cloth face covering and wash hands immediately after removing.

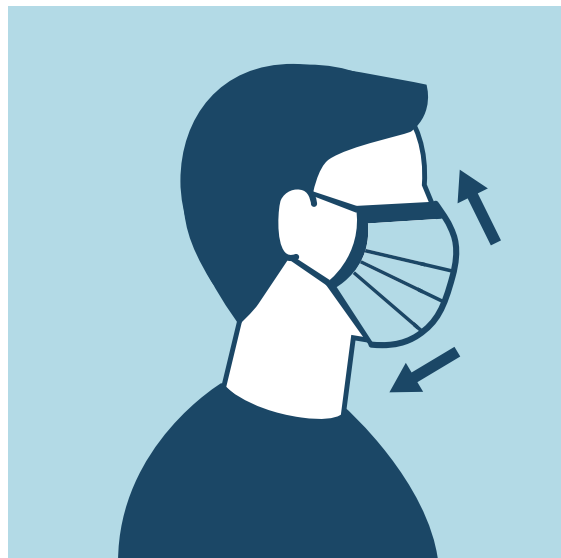

# Sewn Cloth Face Covering

## Materials

- Two 10"x6" rectangles of cotton fabric
- Two 6" pieces of elastic (or rubber bands, string, cloth strips, or hair ties)
- Needle and thread (or bobby pin)
- Scissors
- Sewing machine

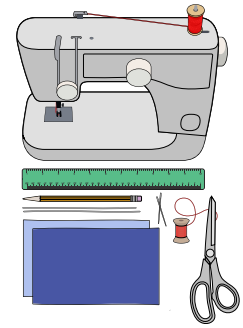

## Tutorial

1. Cut out two 10-by-6-inch rectangles of cotton fabric. Use tightly woven cotton, such as quilting fabric or cotton sheets. T-shirt fabric will work in a pinch. Stack the two rectangles; you will sew the cloth face covering as if it was a single piece of fabric.

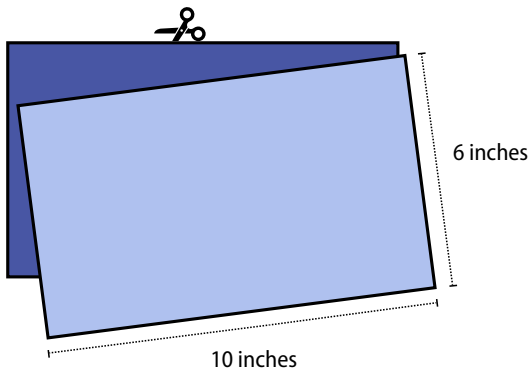

2. Fold over the long sides  $\frac{1}{4}$  inch and hem. Then fold the double layer of fabric over  $\frac{1}{2}$  inch along the short sides and stitch down.

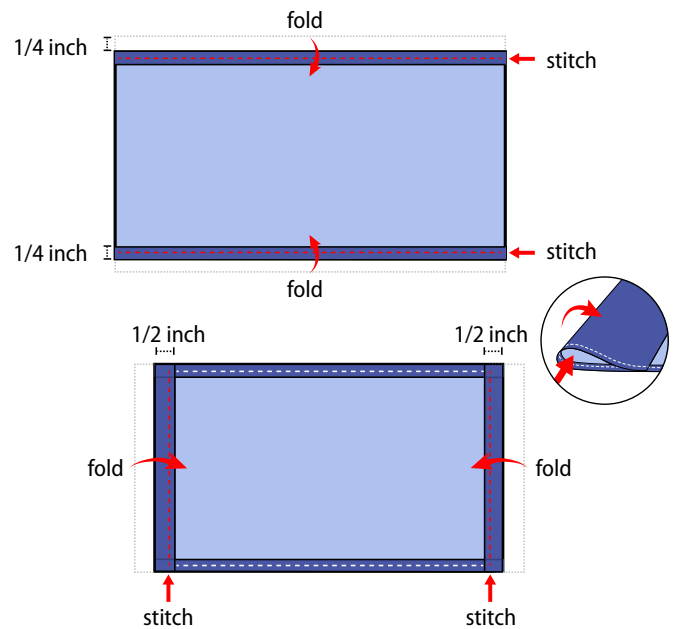

3. Run a 6-inch length of  $\frac{1}{8}$ -inch wide elastic through the wider hem on each side of the cloth face covering. These will be the ear loops. Use a large needle or a bobby pin to thread it through. Tie the ends tight. Don't have elastic? Use hair ties or elastic head bands. If you only have string, you can make the ties longer and tie the cloth face covering behind your head.

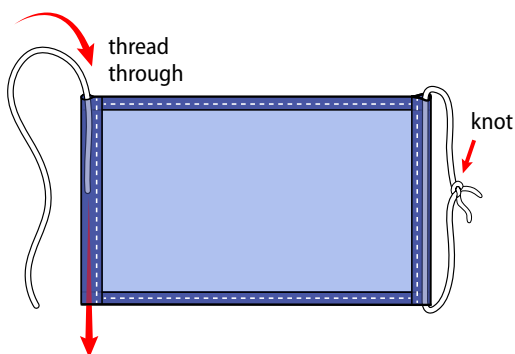

4. Gently pull on the elastic so that the knots are tucked inside the hem. Gather the sides of the cloth face covering on the elastic and adjust so the cloth face covering fits your face. Then securely stitch the elastic in place to keep it from slipping.

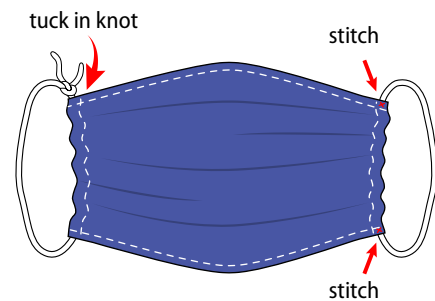



# Quick Cut T-shirt Cloth Face Covering (no sew method)

## Materials

- T-shirt
- Scissors

## Tutorial

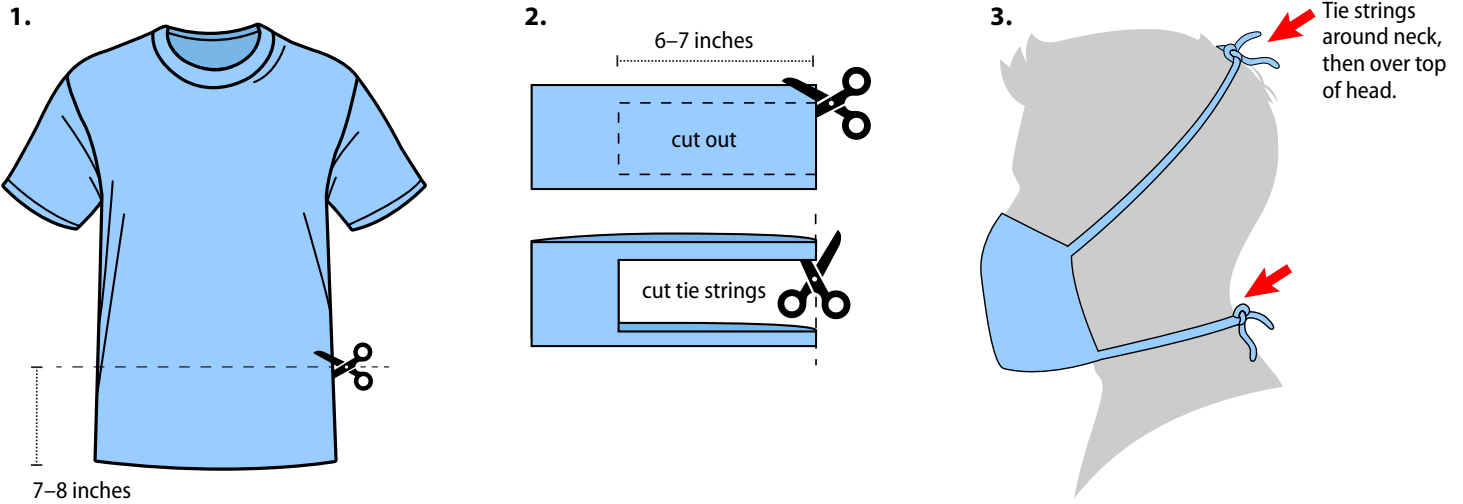

# Bandana Cloth Face Covering (no sew method)

## Materials

- Bandana (or square cotton cloth approximately 20"x20")
- Coffee filter
- Rubber bands (or hair ties)
- Scissors (if you are cutting your own cloth)

## Tutorial

